

Wire the transducer into the relevant PULSAR*ultra* instrument as shown in figure 6. Terminal numbers will depend on the unit.

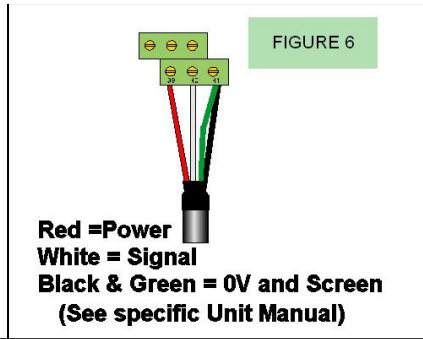

NOTE: All extension cables must use 2 or 3 core screened cables not exceeding 100nF between conductor to screen and 40 ohms/conductor.

The installation is now complete; refer to the PULSAR*ultra* user manual for instructions on how set up the PULSAR*ultra* instrument.

dB Flange Dimensions

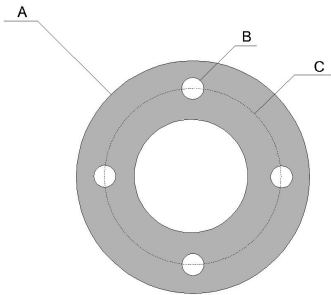

DIN (BS 4504)

Size	A	B	C	No. holes
50	165	19	125	4 -18mm
80	200	19	160	8 -18mm
100	220	19	180	8 -18mm
150	286	19	240	8 -23mm
200	337	19	295	12 -23mm

ANSI Class 150

Size	A	B	C	No. holes
2	165	19	121	4 -18mm
3	200	19	152	4 -18mm
4	220	19	190	8 -18mm
6	286	19	241	8 -22mm
8	343	19	298	8 -22mm

All dimensions in mm

SPECIFICATIONS

Model	Range in metres	Blanking Distance	Operating Frequency	Housing diameter	Housing Height
dBmach3	2.5m	0m	125kHz	180 (sunshield)	205
dB3	3m	0.125m	125kHz	78	115
dB6	6m	0.3m	75kHz	86	106
dB10	10m	0.3m	50kHz	86	106
dB15	15m	0.5m	40kHz	86	122
dB25	25m	0.6m	30kHz	105	142
dB40	40m	1.2m	20kHz	205	223

Process Connection: 1" BSP or NPT

Operating Temperature: -40 to +90 °C (dB3/dBmach3 -30 to +90 °C)

In hazardous area -40 to +75 °C (dB3/dBmach3 -30 to +75 °C)

Ingress Protection: IP68

CE Approval: Meets BS EN 61326-1 for emissions and immunity when used in conjunction with the PULSAR*ultra* or Blackbox range of products

EC DECLARATION OF CONFORMITY

Pulsar Process Measurement Ltd. Declares under our sole responsibility that the product(s) listed below conform with the relevant provisions of the ATEX directive 94/9/EC & EMC directive 2004/108/EC.

Product(s): dB3, dBmach3, dB6, dB10, dB15, dB25 & dB40

Notified Body: Sira Certification Service (0518)
 Rake Lane
 Ecclestone
 Chester
 CH4 9JN

Conformity has been demonstrated with reference to the following documentation:

EC type examination certificate Sira 02ATEX2103X (EEx ia) and 02ATEX5104X (EEx m) dated 4th July 02

Quality Assurance Notification Sira 02ATEXM230 dated 11th December 02

Compliance with the Essential Health & Safety Requirements has been assessed by reference to the following relevant standards:

EN 60079

EN 61326-1

S. Lycett

Date 1st July 2010

Steve Lycett – Engineering Manager



PULSAR Process Measurement Limited

Cardinal Building
 Enigma Commercial Centre
 Sandy's Road
 Malvern
 WR14 1JJ
 United Kingdom

Tel: +44 (0)1684 891371

Fax: +44 (0)1684 575985

email: info@pulsar-pm.com

<http://www.pulsar-pm.com>

©Pulsar Process Measurement Ltd 2015



dB series TRANSDUCERS INSTRUCTION MANUAL

APPLICATIONS

The dB transducer range has been specified and designed to meet the demanding requirements of today's process level measurement applications for liquids and solids.

The dB transducers incorporate the latest in ultrasonic design technology to provide a transducer suitable for the majority of short range liquid and solids level applications.

Several unique and innovative features are included in the dB transducers, including the unique low energy interface between the transducer and the PULSAR*Ultra* range of level and flow measurement instrumentation. This low power interface has enabled the transducers to achieve Intrinsic Safety (EEx ia) approval. The transducer interface is also frequency independent allowing transducers to be interchanged without "re-tuning" the drive electronics. There are several patents applied for covering these designs.

The dB unit is based on a PZT ceramic transducer element. The nominal beam angle is 10° @ -3 dB (depending on unit). When coupled with the DATEM® signal processing used in the PULSAR*Ultra* range of level and flow measurement instrumentation, they provide unmatched performance in industrial process level measurement.

All dB transducers are fitted with integral temperature compensation.

Standard cable lengths 5, 10, 20 or 30m.

Optional submersion shield is available to prevent spurious signal if the transducer becomes submerged.

A range of flange mounting options (ANSI & DIN) with or without a PTFE facing to give improved chemical resistance is available.

An aiming kit is recommended for solids level measurement to help coincide with the material surface and the angle of repose.

Hazardous Area Installation

All dB transducers are ATEX certified for use in hazardous areas.

There are two different versions:

One certified to EEx ia IIC T6 (Sira 02ATEX2103X) for use in zone 0, 1 & 2 applications (safety barrier required), and another certified to EEx m II T6 (Sira 02ATEX5104X) suitable for use in zones 1 & 2 (no barriers required).

The 'X' in the certification No.'s indicates the following special conditions apply:

EEx ia version – Due to the plastic housing it is possible an electrostatic discharge may be generated, therefore when used for applications that specifically require group II category 1, do not install in conditions that are conducive to the build up of electrostatic charge. Additionally, clean only with a damp cloth.

EEx m version – This version must be supplied from apparatus that provides protection from prospective short circuit currents up to 4000A. The Ultra and Blackbox units provide these fuses.

INSTALLATION

The dB transducer should be installed directly above the liquid or solid level with the transducer axis perpendicular to the surface to be measured.

The transducer can be installed using the 1" BSP thread on the top of the transducer or with the supplied 1" BSP to M20 thread adapter. See figure 1 for examples.

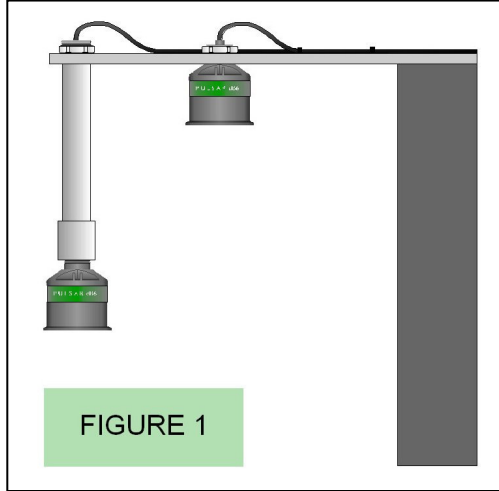

FIGURE 1

Flanged versions of the transducer should be installed using plastic bolts with an insulating gasket between the transducer flange and the process vessel flange. The bolts should not be fully tightened as this may cause acoustic resonance that results in increased ring down. A typical flange application is shown in figure 2.

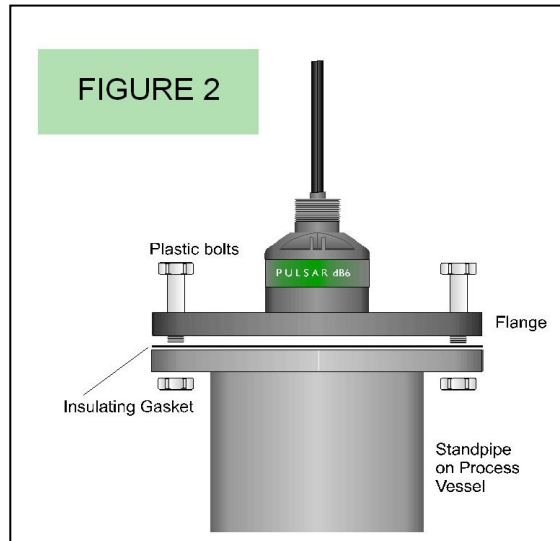

FIGURE 2

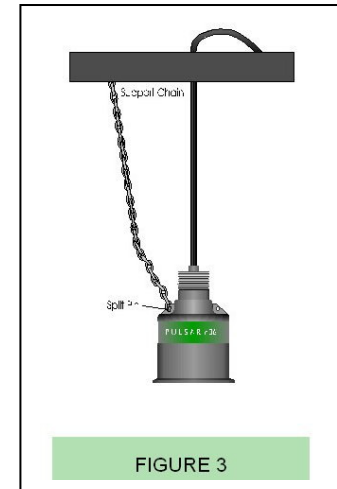

FIGURE 3

In some applications it may not be possible to install the transducer using either a flange or the 1" BSP thread, in these circumstances it may be possible to suspend the transducer from its cable. In these installations it is recommended that the transducer be secured using a small chain fitted to one of the chain holes on the top of the transducer, see figure 3.

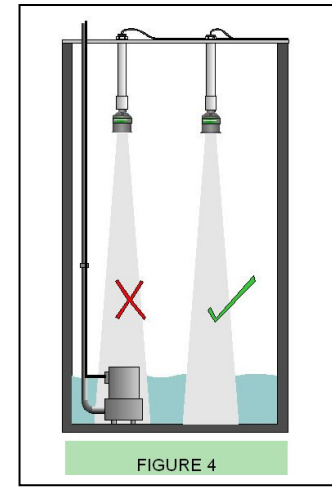

FIGURE 4

When installing the transducer avoid aiming the transducer directly at fixed obstructions as they may mask the required return echo from the liquid or solid level being monitored, see figure 4.

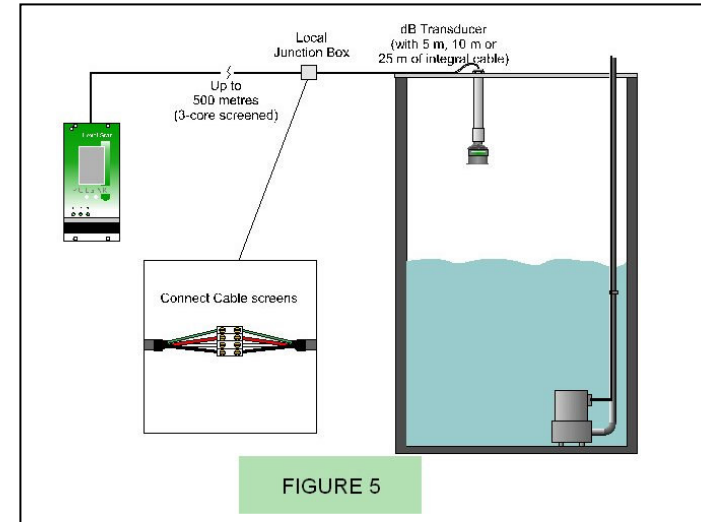

FIGURE 5

Once the transducer is installed in position the cable can be routed back to the PULSAR*Ultra* instrumentation and wired up. If the integral cable is too short an extension cable and junction box may be used, see figure 5. The cable can be extended up to 500 m.